

Intended use

Your Black & Decker steam mop has been designed for sanitising and cleaning sealed hardwood, sealed laminate, linoleum, vinyl, ceramic tile, stone and marble floors and for refreshing carpets. This appliance is intended for indoor household use only.

Safety instructions



Warning! Read all safety warnings and all instructions. Failure to follow the warnings and instructions listed below may result in electric shock, fire and/or serious injury.



Warning! When using mains-powered appliances, basic safety precautions, including the following, should always be followed to reduce the risk of fire, electric shock, personal injury and material damage.

- ◆ Read all of this manual carefully before using the appliance.
- ◆ The intended use is described in this manual. The use of any accessory or attachment or the performance of any operation with this appliance other than those recommended in this instruction manual may present a risk of personal injury.
- ◆ Retain this manual for future reference.

Using your appliance

- ◆ Do not direct steam at people, animals, electrical appliances or electrical outlets.
- ◆ Do not expose to rain.
- ◆ Do not immerse the appliance in water.
- ◆ Do not leave the appliance unattended.
- ◆ Do not leave the appliance connected to an electrical outlet when not in use.
- ◆ Never pull the power lead to disconnect the appliance from the socket. Keep the appliance lead away from heat, oil and sharp edges.
- ◆ Do not handle steam cleaner with wet hands.
- ◆ Do not pull or carry by cord, use cord as a handle, close door on cord, pull cord around sharp corners or expose cord to heated surfaces.
- ◆ Do not use appliance in an enclosed space filled with vapour given off by oil-base paint thinner, some moth-proofing substances, flammable dust, or other explosive or toxic vapours.
- ◆ Check the type of floor with the manufacturer.
- ◆ Do not use on leather, wax polished furniture or floors, synthetic fabrics, velvet or other delicate, steam-sensitive materials.



Warning! Do not use on unsealed wood or unsealed laminate floors. On surfaces that have been treated with wax or some no wax floors, the sheen may be removed by the heat and steam action. It is always recommended to test an isolated area of the surface to be cleaned before proceeding. We also recommend that you check the use and care instructions from the floor manufacturer.

- ◆ Never put descaling, aromatic, alcoholic or detergent products into the steam cleaner, as this may damage it or make it unsafe for use.
- ◆ If the home circuit breaker activates while using the steam function, discontinue product use immediately and contact the customer support centre. (Beware of the risk of electrical shock.)
- ◆ The appliance emits very hot steam to sanitize the area of use. This means that the steam head, cleaning pads and carpet attachment get very hot during use.
- ◆ **Caution!** Always wear suitable shoes when using your steam mop and when changing the accessories on your steam mop. Do not wear slippers or open toed footwear.
- ◆ The lid may become hot during use.
- ◆ Steam may escape from the appliance during use.
- ◆ Care should be taken when using this appliance. DO NOT touch any parts which may become hot during use.
- ◆ Switch the appliance off and return the handle to the upright position before removing the cap from the water tank.
- ◆ For floor use only; do not use the unit upside down. This appliance is intended for indoor household use only.

After use

- ◆ Unplug the appliance and allow to cool before cleaning.
- ◆ When not in use, the appliance should be stored in a dry place.
- ◆ Children should not have access to stored appliances.

Inspection and repairs

- ◆ Unplug the appliance and allow to cool before performing any maintenance or repairs.
- ◆ Before use, check the appliance for damaged or defective parts. Check for breakage of parts, damage to switches and any other conditions that may affect its operation.
- ◆ Regularly check the power lead for damage.
- ◆ Do not use the appliance if any part is damaged or defective.
- ◆ Have any damaged or defective parts repaired or replaced by an authorized repair agent.
- ◆ Never attempt to remove or replace any parts other than those specified in this manual.

Safety of others

- ◆ This appliance is not intended for use by persons (including children) with reduced physical, sensory or mental capabilities, or lack of experience and knowledge, unless they have been given supervision or instruction concerning the use of the appliance by a person responsible for their safety.
- ◆ Children should be supervised to ensure that they do not play with the appliance.

Residual risks.

Additional residual risks may arise when using the tool which may not be included in the enclosed safety warnings. These risks can arise from misuse, prolonged use etc.

Even with the application of the relevant safety regulations and the implementation of safety devices, certain residual risks can not be avoided. These include:

- ◆ Injuries caused by touching any moving parts.
- ◆ Injuries caused by touching any hot parts.
- ◆ Injuries caused when changing any parts or accessories.
- ◆ Injuries caused by prolonged use of the appliance. When using any appliance for prolonged periods ensure you take regular breaks.

Electrical safety



Warning! This product must be earthed.
Always check that the power supply corresponds to the voltage on the rating plate.

Power plugs must match the outlet. Never modify the plug in any way. Unmodified plugs and matching outlets will reduce risk of electric shock.

- ◆ **If the supply cord is damaged, it must be replaced by the manufacturer or an authorised Black & Decker Service Centre in order to avoid a hazard.**

Extension cables & Class 1 product

- ◆ **A 3-core cable must be used as your appliance is earthed and of Class 1 construction.**
- ◆ **Up to 30m (100 ft) can be used without loss of power.**

Labels on the appliance

The following pictograms are shown on the tool:



Warning! To reduce the risk of injury, the user must read the instruction manual.



Warning! Danger of scalding.

Features

This appliance includes some or all of the following features.

1. ON/Off switch
2. Autoselect™ dial
3. Water tank
4. Handle
5. Steam Head
6. Cleaning pad
7. Resting mat
8. Carpet glider (FSM1600 & FSM1600D only)
9. Jug (FSM1600 & FSM1600D only)

Assembly

Warning! Before attempting any of the following operations, make sure that the appliance is switched off and unplugged and that the appliance is cold and does not contain any water.

Attaching the handle (Fig. A & B)

- ◆ Slide the hand grip (10) into the top end of the handle (4) until it clicks into place.
- ◆ Slide the bottom end of the handle (4) into the top end of the steam mop body (11) until it clicks into place.
- ◆ The handle can be removed from the Steam mop body for easy storage by pressing the handle tube release button (12) and pulling the handle (4) out of the steam mop body (11).

Attaching the steam head (Fig. C)

- ◆ Slide the bottom end of the steam mop body (11) onto the steam head (5) until it clicks into place.
- ◆ The steam head can be removed from the Steam mop body by pressing the steam head release button (13) and pulling the steam mop body (11) off the steam head (5).

Attaching a cleaning pad (Fig. D)

Replacement cleaning pads are available from your Black & Decker dealer (cat. no. FSMP20-XJ).

- ◆ Place a cleaning pad (6) on the floor with the 'hook & loop' side facing up.
- ◆ Lightly press the steam mop down onto the cleaning pad (6).

Caution! Always place your steam mop on the resting mat (7) with the handle (4) in the upright position when stationary and make sure the steam mop is turned off when not in use.

Removing a cleaning pad (Fig. E)

Caution! Always wear suitable shoes when changing the cleaning pad on your steam mop. Do not wear slippers or open toed footwear.

- ◆ Return the handle (4) to the upright position and turn the steam mop 'OFF'.

- ◆ Place the steam mop on the resting mat and wait until it cools down. (approximately five minutes)
- ◆ Place the front of your shoe onto the cleaning pad removal tab (14) and press down firmly.
- ◆ Lift the steam mop up off the cleaning pad.

Caution! Always place the steam mop on the resting mat (7) with the handle (4) in the upright position when stationary and make sure the steam mop is turned off when not in use.

Attaching the carpet glider (Fig. F) (FSM1600 & FSM1600D only)

- ◆ Place carpet glider on the floor.
- ◆ Lightly press the steam mop down onto the carpet glider (8) until it clicks into place.

Caution! Always place the steam mop on the resting mat (7) with the handle (4) in the upright position when stationary and make sure the steam mop is turned off when not in use.

Removing the carpet glider (Fig. G) (FSM1600 & FSM1600D only)

Caution! Always wear suitable shoes when changing the carpet glider on your steam mop. Do not wear slippers or open toed footwear.

- ◆ Return the handle (4) to the upright position and turn the steam mop 'OFF'.
- ◆ Place the steam mop on the resting mat and wait until it cools down. (approximately five minutes)
- ◆ Place the front of your shoe onto the carpet glider removal tab (15) and press down firmly.
- ◆ Lift the steam mop up off the carpet glider (8).

Caution! Always place the steam mop on the resting mat (7) with the handle (4) in the upright position when stationary and make sure the steam mop is turned off when not in use.

Filling the water tank (Fig. H, I & J)

This Steam Mop incorporates an anti-calc system to help prolong the life of the system.

Note: Fill the water tank with clean tap water.

Note: In areas of very hard water, the use of de-ionised water is recommended.

- ◆ Ensure that the appliance is switched off and the power cord is disconnected from the mains.
- ◆ Place the steam mop on the resting mat (7) with the handle (4) in the upright position.
- ◆ Remove the filler cap (16) by turning it anti-clockwise.
- ◆ Fill the tank (3) with water.

Warning! Your tank has a 0.5 litre capacity. Do not fill the tank above the Max fill mark.

- ◆ Fit the filler cap (16) by turning it firmly clockwise.

Note: When not in use, the jug may be clipped to the handle for convenient storage (Fig. J) (FSM1600 & FSM1600D only)

Use

Switching on and off

- ◆ To switch the appliance on, press the ON/OFF button (1). It takes approximately 15 seconds for the steam mop to heat up.

Note: When the steam mop is first turned on the water reservoir will glow red. Once the steam mop is ready to use the water reservoir will glow blue.

- ◆ To switch the appliance off, press the ON/OFF button (1).

Caution! Never leave the steam mop in one spot on any surface for any period of time. Always place the steam mop on the resting mat (7) with the handle (4) in the upright position when stationary and make sure the steam mop is turned off when not in use.

Caution! Always empty the steam mop after use.

Autoselect™ Technology

This steam mop is fitted with an Autoselect™ dial (2) which shows various cleaning applications. They are used to select the correct operating mode for your particular cleaning operation.

Using the Autoselect™ dial (2), choose from one of the following applications:

	Wood/Laminate
	Stone/Marble
	Tiles/Vinyl

The steam mop will select the correct volume of steam required for your particular cleaning operation.

Hints for optimum use

General

Caution! Never use the steam mop without first attaching a cleaning pad.

- ◆ Always vacuum or sweep the floor before using the steam mop.
- ◆ The easiest way to use the machine is to tilt the handle to a 45° angle and clean slowly, covering a small area at a time.
- ◆ Do not use chemical cleaners with your steam mop. To remove stubborn stains from vinyl or linoleum floors, you can pre-treat with a mild detergent and some water before using the steam mop.

Steam cleaning

- ◆ Place a cleaning pad (6) on the floor with the 'hook & loop' side facing up.
- ◆ Raise the steam mop off the resting mat (7) and lightly press it down onto the cleaning pad (6).
- ◆ Place the steam mop on the resting mat.
- ◆ Connect the steam mop to the mains.
- ◆ Turn the Autoselect™ dial (2) to the required setting.
- ◆ Press the ON/OFF button (1). It takes approximately 15 seconds for the steam mop to heat up.
- ◆ Pulling the handle (4) back will activate the steam pump. After a few seconds steam will start to come out of the steam head.
- ◆ It take a few seconds for steam to enter the cleaning pad. The steam mop will now glide easily over the surface to be sanitised/cleaned.
- ◆ Push and pull the steam mop slowly across the floor to thoroughly steam clean each section.

Note: During use you may turn off the steam pump by returning the handle to the upright position, this convenient feature will allow you to place the steam mop on the resting mat for a short time so that you may move items of furniture, then continue cleaning without the need to switch the appliance off.

- ◆ When you have finished using the steam mop, return the handle (4) to the upright position and turn it 'OFF', place it on the resting mat (7) and wait until the steam mop cools down. (approximately five minutes)

Caution! It is important to monitor the water level in the water tank. To refill the water tank and continue to sanitise/clean, return the handle (4) to the upright position and turn the steam mop 'OFF'. Unplug the unit from the electrical wall outlet and refill the water tank (3) using the jug (9) supplied.

Caution! Never leave the steam mop in one spot on any surface for any period of time. Always place the steam mop on the resting mat (7) with the handle (4) in the upright position when stationary and make sure the steam mop is turned off when not in use.

Carpet refreshing

- ◆ Place a cleaning pad (6) on the floor with the 'hook & loop' side facing up.
- ◆ Raise the steam mop off the resting mat (7) and lightly press it down onto the cleaning pad (6).
- ◆ Place the carpet glider (8) on the floor.
- ◆ Lightly press the steam mop down onto the carpet glider (8) until it clicks into place.
- ◆ Place the steam mop on the resting mat. (7)
- ◆ Connect the steam mop to the mains.
- ◆ Turn the Autoselect™ dial (2) to the Wood/Laminate setting.
- ◆ Press the ON/OFF button (1). It takes approximately 15 seconds for the steam mop to heat up.

- ◆ Pulling the handle (4) back will activate the steam pump. After a few seconds steam will start to come out of the steam head.
- ◆ Push and pull the steam mop slowly across the carpet to thoroughly refresh each section.

Note: During use you may turn off the steam pump by returning the handle (4) to the upright position, this convenient feature will allow you to place the steam mop on the resting mat (7) so that you may move items of furniture with out the need to switch the appliance off.

- ◆ When you have finished using the steam mop, return the handle (4) to the upright position and turn it 'OFF', place it on the resting mat (7) and wait until the steam mop cools down. (approximately five minutes)

Caution! It is important to monitor the water level in the water tank. To refill the water tank and continue to sanitise/clean, return the handle (4) to the upright position and turn the steam mop 'OFF'. Unplug the unit from the electrical wall outlet and refill the water tank using the jug supplied.

Caution! Never leave the steam mop in one spot on any surface for any period of time. Always place the steam mop on the resting mat (7) with the handle (4) in the upright position when stationary and make sure the steam mop is turned off when not in use.

After use (Fig. K & L)

- ◆ Return the handle (4) to the upright position and turn the steam mop 'OFF',
- ◆ Place the steam mop on the resting mat (7) and wait until the steam mop cools down. (approximately five minutes)
- ◆ Unplug the steam mop from the electrical wall outlet.
- ◆ Empty the water tank (3).
- ◆ Remove the cleaning pad (6) and wash it ready for next use. (Take care to follow the wash care instructions printed on the cleaning pad).
- ◆ Wrap the supply cable around the cable tidy hooks (18 & 19).

Note: The top cable tidy hook (19) rotates to easily release the cable ready for next use.

- ◆ Clip the supply cable into the cable tidy clip (20) close to the plug.
- ◆ Place steam mop on the resting mat (7) for storage.

Note: With the handle (4) in the upright position, the cable neatly wrapped around the cable tidy hooks (18 & 19) and secured in the cable tidy clip (20) your steam mop will stand on its own for storage. Alternatively there is a hanging bracket (21) built into the hand grip (10) which will allow your steam mop to be hung from a suitable hook on the wall. Always ensure that your wall hook is capable of supporting the weight of the steam mop safely.

Maintenance and cleaning

Your Black & Decker corded appliance has been designed to operate over a long period of time with a minimum of maintenance. Continuous satisfactory operation depends upon proper appliance care and regular cleaning.

Warning! Before performing any maintenance or cleaning on corded appliances switch off and unplug the appliance.

- ◆ Wipe your appliance over using a soft damp cloth.
- ◆ For stubborn marks you can use a mild solution of soap and water to dampen your cloth.

Care of the cleaning pads

Wash care instructions - No fabric conditioner - Allow to dry fully before re-use.

Caution! Follow the cleaning instructions printed on the label of the cleaning pad.

Mains plug replacement (U.K. & Ireland only)

If a new mains plug needs to be fitted:

- ◆ Safely dispose of the old plug.
- ◆ Connect the brown lead to the live terminal in the new plug.
- ◆ Connect the blue lead to the neutral terminal.
- ◆ Connect the green/yellow lead to the earth terminal.

Warning! Follow the fitting instructions supplied with good quality plugs. Recommended fuse: 13A.

Protecting the environment



Separate collection. This product must not be disposed of with normal household waste.

Should you find one day that your Black & Decker product needs replacement, or if it is of no further use to you, do not dispose of it with household waste. Make this product available for separate collection.



Separate collection of used products and packaging allows materials to be recycled and used again. Re-use of recycled materials helps prevent environmental pollution and reduces the demand for raw materials.

Local regulations may provide for separate collection of electrical products from the household, at municipal waste sites or by the retailer when you purchase a new product.

Black & Decker provides a facility for the collection and recycling of Black & Decker products once they have reached the end of their working life. To take advantage of this service please return your product to any authorised repair agent who will collect them on our behalf.

You can check the location of your nearest authorised repair agent by contacting your local Black & Decker office at the address indicated in this manual. Alternatively, a list of authorised Black & Decker repair agents and full details of our after-sales service and contacts are available on the Internet at: www.2helpU.com

Technical data

		FSM1600 FSM1600D (Type 2)	FSM1500 (Type 2)
Voltage	V _{ac}	230	230
Power	W	1600	1500
Tank capacity	l	0.5	0.5
Weight	kg	2.52	2.52

Guarantee

Black & Decker is confident of the quality of its products and offers an outstanding guarantee. This guarantee statement is in addition to and in no way prejudices your statutory rights. The guarantee is valid within the territories of the Member States of the European Union and the European Free Trade Area.

If a Black & Decker product becomes defective due to faulty materials, workmanship or lack of conformity, within 24 months from the date of purchase, Black & Decker guarantees to replace defective parts, repair products subjected to fair wear and tear or replace such products to ensure minimum inconvenience to the customer unless:

- ◆ The product has been used for trade, professional or hire purposes;
- ◆ The product has been subjected to misuse or neglect;
- ◆ The product has sustained damage through foreign objects, substances or accidents;
- ◆ Repairs have been attempted by persons other than authorised repair agents or Black & Decker service staff.

To claim on the guarantee, you will need to submit proof of purchase to the seller or an authorised repair agent. You can check the location of your nearest authorised repair agent by contacting your local Black & Decker office at the address indicated in this manual. Alternatively, a list of authorised Black & Decker repair agents and full details of our after-sales service and contacts are available on the Internet at: www.2helpU.com

Please visit our website www.blackanddecker.co.uk to register your new Black & Decker product and to be kept up to date on new products and special offers. Further information on the Black & Decker brand and our range of products is available at www.blackanddecker.co.uk

Partial support - Only parts shown available
 Nur die aufgeführten teile sind lieferbar
 Réparation partielle - Seules les pièces indiquées sont disponibles
 Supporto parziale - Sono disponibili soltanto le parti evidenziate
 Solo están disponibles las piezas listadas
 So se encontram disponíveis as peças listadas
 Gedeeltelijke ondersteuning - alleen de getoonde onderdelen
 zijn beschikbaar

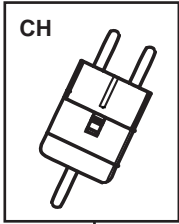

100

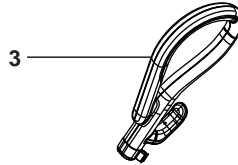

3

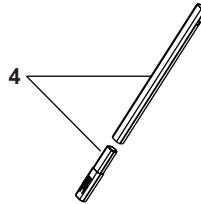

4



7

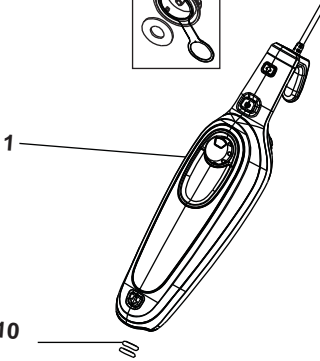

1

10

FSM1600(D)(VP)

5

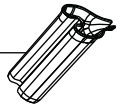

6

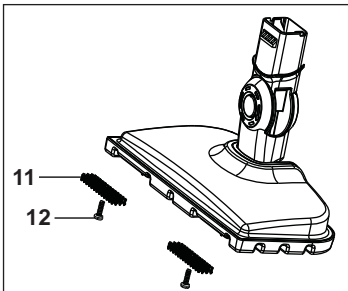
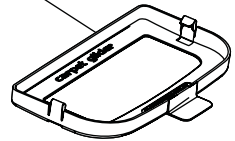

2

8

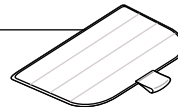

9

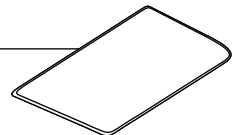

ENGLISH

Do not forget to register your product!

www.blackanddecker.co.uk/productregistration

Register your product online at **www.blackanddecker.co.uk/productregistration** or send your name, surname and product code to Black & Decker in your country.

Australia

Black & Decker (Australia) Pty. Ltd.
20 Fletcher Road, Mooroolbark,
Victoria, 3138

Tel. 03-8720 5100
Fax 03-9727 5940

New Zealand

Black & Decker
5 Te Apunga Place
Mt Wellington
Auckland 1060

Tel. +64 9 259 1133
Fax +64 9 259 1122

United Kingdom

Black & Decker
210 Bath Road
Slough, Berkshire SL1 3YD

Tel. 01753 511234
Fax 01753 551155